

# EJS Series



UL Recognized  
CSA Certified  
VDE Approved\*



## EJS Series

The new EJS series is the next generation of power inlet filters. The 1-15 amp versions are snap-in mounted and mechanically equivalent to the EAS/EBS series. The performance has been enhanced to better meet the needs for more attenuation. The EJS series also has an extended metal flange around the socket for improved high frequency EMI shielding as well as a larger contact area for the panel ground.

The EJS series also includes a 20 amp version that uses the inlet IEC 320/C20. This product was designed to keep up with the demand for higher current equipment. Applications include higher current power supplies and computing equipment, which consist of work stations, base stations, servers, etc.

\*15EJS - VDE rated at 10 amps, 250 VAC  
20EJS - VDE rated at 16 amps, 250 VAC

## Electrical Schematic

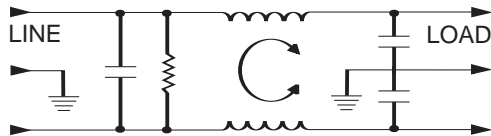

Resistor location for reference only.

## Specifications

**Maximum leakage current, each line-to-ground**  
 @ 120 VAC 60 Hz: .22mA  
 @ 250 VAC 50 Hz: .38mA

**Hipot rating (one minute):**  
 line-to-ground 1500 VAC  
 line-to-line 1450 VDC

**Operating frequency:** 50/60 Hz

**Rated voltage (max.):** 250 VAC

**Minimum insertion loss in dB:**  
 Line-to-ground in 50 ohm circuit

Current Rating	Frequency-MHz								
	.01	.05	.1	.15	.5	1	5	10	30
1A	15	27	32	37	44	52	50	50	50
3A	-	10	15	20	30	39	48	50	60
6A	-	1	5	9	21	28	41	44	54
10A	-	1	4	7	14	18	31	36	51
15A	-	-	-	2	5	8	21	26	40
20A	-	-	3	5	14	21	30	33	42

Line-to-line in 50 ohm circuit

Current Rating	Frequency-MHz								
	.01	.05	.1	.15	.5	1	5	10	30
1A	-	-	5	8	19	27	45	43	9
3A	-	-	5	8	17	20	39	42	11
6A	-	-	5	8	17	21	32	40	16
10A	-	-	5	8	17	21	23	36	16
15A	-	-	5	8	17	23	33	30	11
20A	-	-	5	2	17	25	27	35	48

# EJS Series

## Case Styles

### EJS1 (1-15 amp versions)

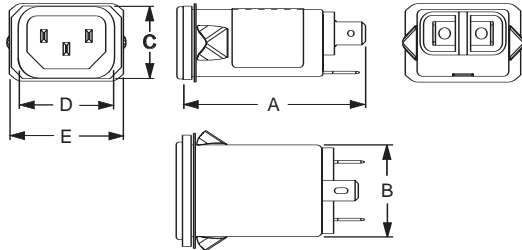

### EJS8 (1-15 amp versions)

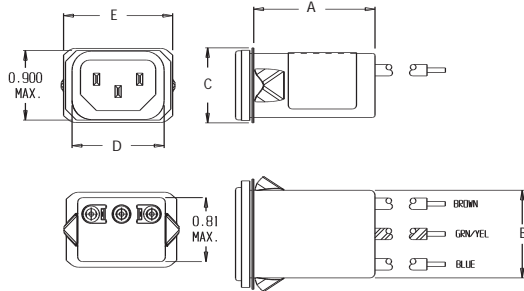

### 20EJS1

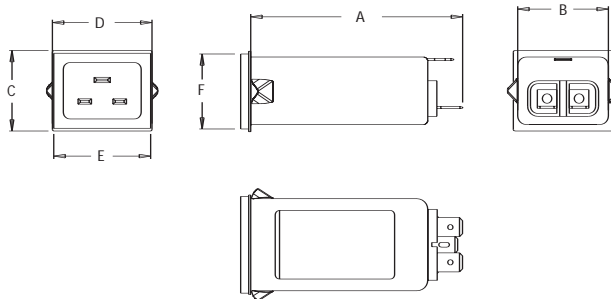

### 20EJS8

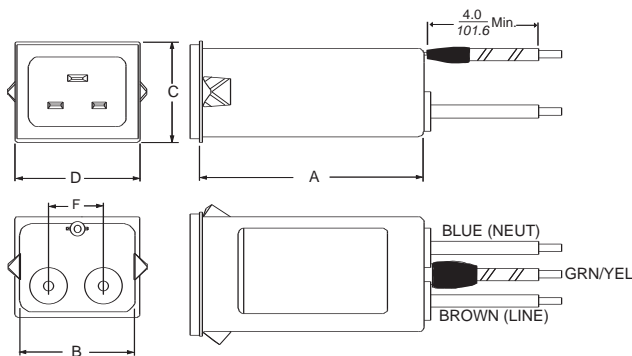

## Case Dimensions

Part No.	A (max)	B (max)	C (max)	D $\pm .015$ $\pm .38$	E (max)	F (ref)
1EJS1, 3EJS1	2.20	1.10	0.96	1.19	1.35	—
6EJS1, 10EJS1	55.88	27.94	24.38	30.10	34.21	—
15EJS1						
1EJS8, 3EJS8	1.54	1.10	0.96	1.19	1.41	—
6EJS8, 10EJS8	39.12	27.94	24.30	30.10	35.81	—
15EJS8						
20EJS1	3.13	1.35	1.18	1.46	1.42	—
	79.38	34.29	29.99	37.08	36.07	
20EJS8	2.63	1.35	1.18	1.46	—	.624
	66.80	34.29	29.97	37.08		15.85

## Part Numbers

1EJS1	10EJS1
1EJS8	10EJS8
3EJS1	15EJS1
3EJS8	15EJS8
6EJS1	20EJS1*
6EJS8	20EJS8*
Line Cord No. (1-15A)	GA400
Insulating Boot (1-15A)	FA601

\*UL, CSA — 20 Amp; VDE — 16 Amp

## Recommended Panel Cutouts

1 to 15A EJS - all terminal types

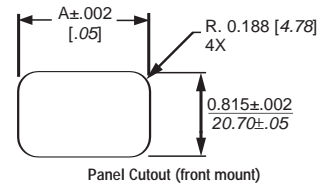

Panel Cutout (front mount)

Panel Thickness	A Dim. ±.002
0.031 - 0.052 [.79 - 1.32]	1.260 [32.00]
0.046 - 0.068 [1.17 - 1.73]	1.350 [34.29]

### 20EJS

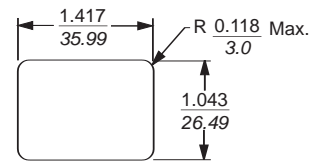

Panel Cutout (front mount)

Tolerance ±.005 [0.13]  
Panel Thickness: 0.031 to 0.047 [.79-1.19]